

PRO-36 | COMPACT DRILLING MACHINE



The most compact machine designed by Promotech, and one of the smallest units in the world. Superior features of PRO-36 include:

- ultra light weight
- gear box and slide system made of one piece
- purpose designed motor with heavy duty gear box
- maintenance friendly design
- maintenance free rail guide system

PRO-36 is equipped with the latest generation of electromagnetic base with magnetic field shape control system (MFSC) and magnetic power adhesion control module (MPAC), which detects adhesive force of electromagnetic base and protects both the machine and the operator from work on too thin workpiece.

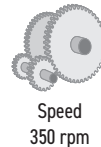
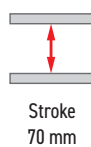
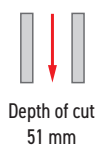

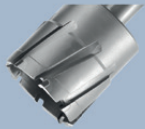

Max
Ø 36 mm
(1 7/16")

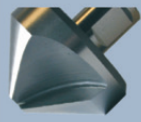

Max
Ø 40 mm
(1 9/16")



Max
Ø 12 mm
(1/2")

PRO-36 TECHNICAL SPECIFICATION

Motor Speed (under load)	350 rpm
Power	1020 W
Weight	10 kg
Max milling capacity	36 mm (1 7/16")
Max drilling capacity	12 mm (1/2")
Max countersinking	40 mm (1 9/16")
Stroke	70 mm (2 3/4")
Max depth of cut	51 mm (2")
Voltage	1~ 220-240 V, 50-60 Hz 1~ 110-120 V, 50-60 Hz
MPAC (Magnetic Power Adhesion Control)	yes
MFSC (Magnetic Field Shape Control)	yes
Magnetic clamping force (surface with the thickness of 25 mm and roughness Ra = 1.25)	917 kgf (9000 N)
Magnet Base Dimensions	80 x 161 x 36,5 [mm] 3-1/8 x 6-5/16 x 1-7/16 ["]
Min. Workpiece Thickness	6 mm (1/4")
Tool holder	19 mm (3/4") Weldon
Product Code 230V/50Hz	WRT-0440-10-20-00-4
Product Code 115V/60Hz	WRT-0440-10-10-00-4

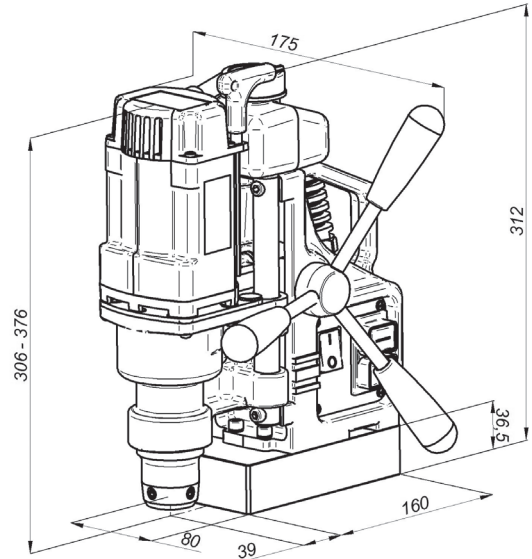

Standard shipping set:

- Magnetic Base Drilling Machine
- Plastic Box
- Swarf Shield/Cutter Guard
- Coolant Bottle Assembly
- Safety Chain with Snap Hook
- Allen wrench hex s=4
- Operator's Manual
- Standard shipping weight - 16,7 kg (36 lbs)

Selected additional accessories:

- UKL-0440-16-00-00-0 Coolant System 2l
- PDS-0587-10-00-00-0 Vacuum pad
- ZSP-0587-11-00-00-0 Compressed air ejector
- PDS-0110-03-00-01-0 Pipe attachment DMP 251 for pipes with diameters of 80-250 mm (3-10")

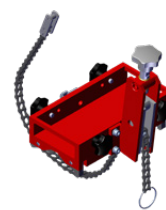

Pipe attachment DMP 251



Coolant System 2l



Vacuum pad



Compressed air ejector

All information is subject to change without notice. 23.03



PROMOTECH FABRICATION MACHINES PVT LTD

Corporate Office :
C 8, DSIIDC Packaging Complex
Kirti Nagar New Delhi - 110015

Mobile: +91 966 766 0304
india@promotech.eu
www.promotech-india.in

Your local dealer:

